

Fixation of medial neck fractures or intertrochanteric fractures of the femur

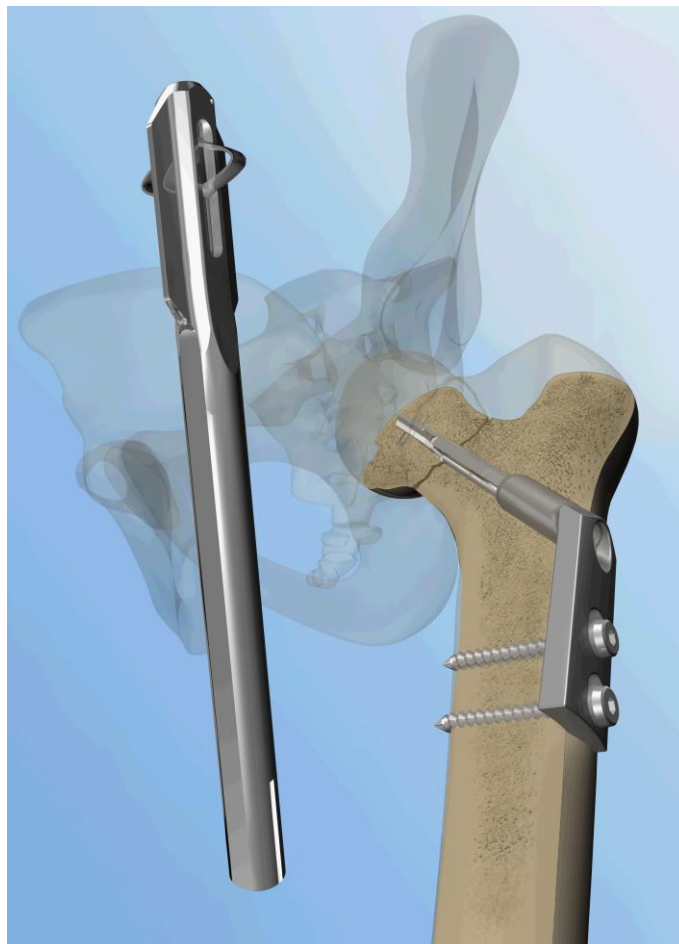

Manufacturer:



BAAT MEDICAL PRODUCTS

Hazemeijer Hengelo
F. Hazemeijerstraat 800/A04
7555 RJ Hengelo
The Netherlands
Phone: +31 88 5656600
info@baatmedical.com
www.baatmedical.com

Distributor:



GANNET IMPLANT

Hazemeijer Hengelo
F. Hazemeijerstraat 800/A04
7555 RJ Hengelo
The Netherlands
Phone: +31 85 401 26 45
info@gannetimplant.com
www.gannetimplant.com

The information presented in this brochure is intended to demonstrate GANNET product. Always refer to the package insert, product label and/or user instructions before using any GANNET product. Surgeons must always rely on their own clinical judgment when deciding which products and techniques to use with their patients. Products may not be available in all markets. Product availability is subject to the regulatory or medical practices that govern individual markets. Please contact your Gannet Implant representative if you have questions about the availability of GANNET products in your area.

Table of contents

Introduction	4
Features.....	4
Intended purpose	4
Clinical Benefits.....	4
Indications and contraindications	4
Indications	4
Relative contraindications	4
Warnings and Precautions.....	5
Potential Adverse Effects.....	6
Procedure overview	7
1. Fracture reduction	8
2. Approach	8
3. Guide Pin insertion.....	8
4. Length determination	9
5. Drilling.....	10
6. Gannet Blade and Plate assembly.....	10
7. Setting the Gannet Introducer	10
8. Gannet Introducer and Blade and Plate assembly	11
9. Gannet Blade and Plate one-step insertion.....	11
10. Plate impaction.....	12
11. Plate fixation	12
12. Gannet Impaction Anchor deployment	12
13. Final check and wound closure	13
Gannet Implant removal.....	14
Procedure overview	14
1. Approach	14
2. Retraction of Impaction Anchors.....	14
3. Removal of Gannet Self-Tapping Cortical Screws.....	14
4. Extraction of Gannet Blade and plate	14
5. Final check and wound closure	14
References	15
Ordering Information	16
Catalogue	16
Gannet Blade	16
Gannet Self-Tapping Cortical Screws.....	16
Gannet Instruments	17

Introduction

Features

The Gannet implant is a surgical device specially designed for the stable fixation of neck fractures and stable intertrochanteric fractures of the femur. The Gannet implant is a dynamic, low volume device providing rotational and angular stability of the femoral head. Two side wings provide superior rotational stability while the device is locked in the femoral head by deployment of two impaction anchors. The Gannet implant is minimal invasive to the femoral head, because of the low implant volume. Due to its design the Gannet implant preserves the remaining vascularisation of the femoral head, and provides the stability necessary for the revascularisation and primary bone healing of the femoral neck fracture. The Gannet implant offers surgeons a straightforward and very familiar technique, and quality instrumentation to perform successful femoral neck and stable intertrochanteric fracture procedures, whilst minimizing complications.

Intended purpose

Treat stable extracapsular intertrochanteric (perthrochanteric) femur fractures and intracapsular femoral neck fractures by trained surgeons in a hospital environment.

Clinical Benefits

Surgical treatment of hip fractures compared to conservative management:

- In general, 30-day and 1-year mortalities are higher in conservatively treated patients compared to surgical treatment (van de Ree et al., 2017)
- SHS compared to other surgical treatments lowers the amount of blood loss during surgery, has a shorter operating time and a low infection rate (Liang, Yang, Lin, & Fan, 2015)
- The Gannet provides the stability necessary for the revascularisation and union of the femoral neck fracture.

Indications and contraindications

Indications

- Stable adult intertrochanteric (perthrochanteric) femur fractures; classified as 31-A1 by the AO/OTA system.
- Displaced and non-displaced adult femoral neck fractures.

Relative contraindications

- Local infection or inflammation
- Compromised bone stock
- Unstable intertrochanteric (perthrochanteric) femur fractures and/or fractures with multiple fragments, that cannot be classified as stable adult two (2) part intertrochanteric (perthrochanteric) femur fractures
- Material sensitivity
- Morbid obesity
- Inadequate local tissue coverage
- Any mental or neuromuscular disorder, which would create an unacceptable risk of fixation failure or complications in postoperative care.
- Other medical or surgical conditions, which would preclude the potential benefit of surgery.

Warnings and Precautions



Patient selection

Appropriate patient selection is critical to the surgical outcome. Only patients who satisfy the indications AND who do not have any of the contraindications should be considered for trauma surgery using the Gannet implants and instruments to avoid adversely affecting device performance or surgical outcome.



Patient education

Preoperative instructions to the patient are essential. The patient should be made aware of the limitations and potential adverse effects of the surgery. The patient should be instructed to limit the postoperative activity as this will reduce the risk of bent, broken and/or loose implant components. The patient must be made aware that implant components may bend, break and/or loosen, even though restrictions in activity are followed.



Single activation only

The wings of the Gannet Blade are single use and should not be activated prior to implantation.



Instruments

Only use instruments and accessories listed in the surgical technique to avoid adversely affecting device performance or surgical outcome. The surgical team must verify that the instruments are in good condition and in operating order prior to use during surgery.



Use-by date and sterility

Before using the Gannet implants check the use-by date (YYYY/MM/DD) and sterility marker on the packaging. Do not use the implant after its expiration date or if the marker does not indicate it is irradiated, this can lead to infection.



Packaging integrity

Before use of the Gannet implants and instruments check the secondary packaging, labelling and sterile primary packaging are intact. The sterile packaging should be free of cracks, holes, tears and any other damage. Use of an Implant or instrument from a damaged packaging can lead to an untraceable product or infection.



Fracture reduction

Appropriate reduction is important for the fusion and vascularization of the fracture.



Size selection

The Gannet implant is available in a wide variety of sizes to ensure appropriate sizing of the implanted components. Correct size selection is critical to the surgical outcome. An under- or oversized implant can lead to premature failure of the implant.



Implant placement

The Gannet implant is available in a wide variety of sizes to ensure appropriate sizing of the implanted components. Correct size selection is critical to the surgical outcome. An under- or oversized implant can lead to premature failure of the implant.



Implant handling

The Gannet implant is available in a wide variety of sizes to ensure appropriate sizing of the implanted components. Correct size selection is critical to the surgical outcome. An under- or oversized implant can lead to premature failure of the implant.



Imaging

Confirm by means of the appropriate imaging technique (e.g. fluoroscopy) the correct position and/or direction of the instrument or implant. This is important for correct and safe application of the instrument or implant and prevent harm to patient and/or user.



Powered instruments

The use of an powered instrument for drilling or driving a bone screw in position can damage the anatomical structures or damage the implant or instruments.



Single use only

The Gannet implants are provided as single use implants only, and are not to be reused, resterilized or reimplanted in any situation as this might adversely affect device performance and/or increase risk of infection.



MR safety

The effects of MR on Gannet implant have not been tested. Based upon study of scientific literature it can be concluded that a majority of patients with orthopedic implants have been imaged with MR without incident with respect to implant displacement and heating. The Gannet implant will distort (imaging artifacts) the image in vicinity of the implant.

Potential Adverse Effects

As with any major surgical procedure, there are risks involved in orthopedic surgery. Potential risks identified with the use of this system include, but are not limited to:

- Loosening, breakage, bending or cracking of the device
- Loss of fracture fixation
- Implant migration or cut-out
- Varus collapse
- Loss of reduction
- Non-union or delayed union
- Femoral head necrosis (avascular necrosis)
- Shortening of the effected bone/fracture site
- Early or late, superficial or deep infections
- Inflammatory reactions
- Intra-operative or periprosthetic femur fractures
- Metal sensitivity or allergic reactions to foreign body
- Neurological problems as a result of surgical trauma
- Vascular problems as a result of surgery (including hemorrhage, hematoma, thrombosis, pulmonary embolism)

Procedure overview

1. The patient is positioned on the fracture table.
2. Gentle anatomical reduction of the fracture.
3. Make a ± 8 cm lateral skin incision.
4. Insert the Guide Pin in the centre/centre position of the femoral head to a depth of 5 mm subchondrally, using the Gannet Aiming Device and the image intensifier.
5. Next, determine the length of the Gannet Blade by using the Gannet Measuring Gauge.
6. After measuring it is advised to advance the guide pin in the first cortex of the acetabulum to stabilize the femoral head during insertion and also to prevent pulling out the guide pin on removal of the drill.
7. Insert the Gannet Stepped Drill over the Guide Pin and drill to a depth of 5 mm subchondrally using the image intensifier.
8. Assemble the Gannet Blade and Plate using the support located in the Gannet Tray. The wings of the Gannet Blade are single use. Do not activate using the Screw and Anchor Driver prior to implantation.
9. Set the Gannet Introducer to the desired length.
10. Lock the Gannet Introducer onto the assembled Gannet Blade and Plate.
11. Place the mounted Gannet Blade and Plate over the Guide Pin and insert in the pre-drilled lateral cortex by gently tapping with a hammer. After the side plate is seated along the lateral cortex, the introducer is released and the locking blade further tapped in the femoral head up to 5 mm subchondrally using the image intensifier. Remove the Guide Pin.
12. The plate can be fully seated by using the Impactor placed in the most proximal cortical screw hole.
13. The side plate is fixed to the proximal femur with two self-tapping cortical screws.
14. By turning the setscrew in the shaft of the locking blade in clockwise direction, the impaction anchors are expanded by which the blade is locked within the femoral head.
15. Ensure the central positioning of the Gannet blade by antero-posterior and axial views. Close the wound.

See the description of each individual step for more information.

1. Fracture reduction

Anatomical reduction is the single most important step in this surgical procedure. No osteosynthesis will overcome any inadequate fracture reduction.

The patient is positioned supine on the fracture table with the fractured hip extended, adducted and slightly endorotated until the patella is in a position parallel to the floor.

The contralateral leg is abducted. The fracture is then carefully reduced by gentle longitudinal traction using an image intensifier in the antero-posterior and axial planes.

An anatomical fracture is strived for. Distraction of the fracture by undue traction should be prevented at all costs.

After the fracture reduction, the anteversion angle of the femoral neck is assessed by axial imaging.

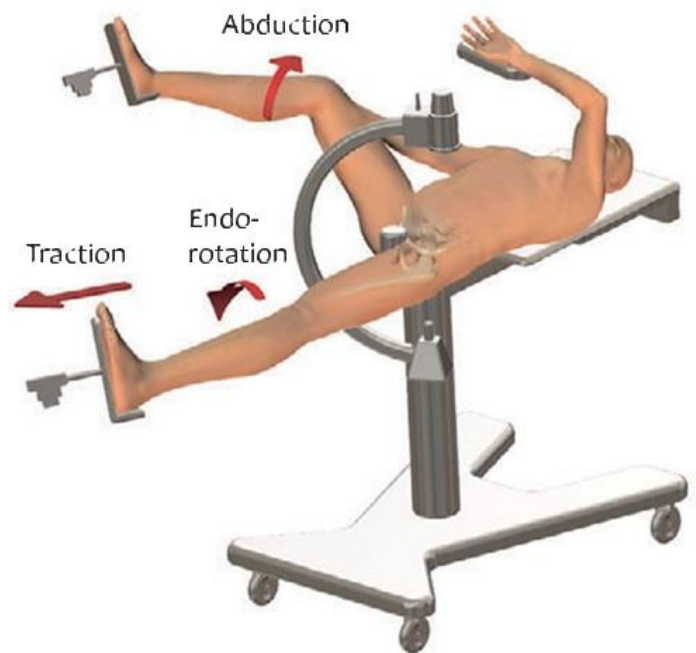

Fracture Reduction

Appropriate reduction is important for the fusion and vascularization of the fracture.

2. Approach

A lateral skin incision of ± 8 cm is made downwards from the lower end of the greater trochanter. The subcutis and the fascia lata are split in line with the skin incision. The vastus lateralis muscle is split longitudinally at its posterior border, and reflected upwards.

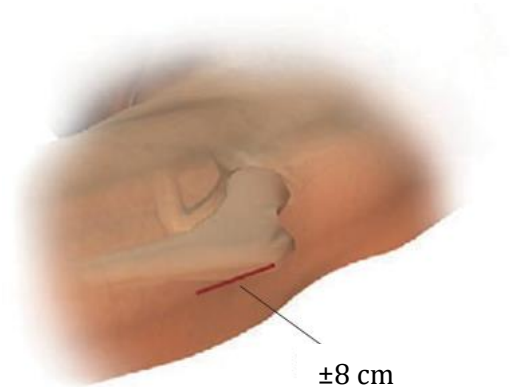

3. Guide Pin insertion

To start with the Guide Pin should be pre-checked if it is absolutely straight. This can be done by rolling it on a flat surface. Also check if the Guide Pin, including the threaded tip, slides smoothly through the cannulated Gannet Stepped Drill.

The Guide Pin should be positioned in the centre/centre position of the femoral head. The 3 mm Guide Pin is to be inserted using the Gannet Aiming Device. The tip of the lesser trochanter must be at the insertion point of the Guide Pin in the antero-posterior view.

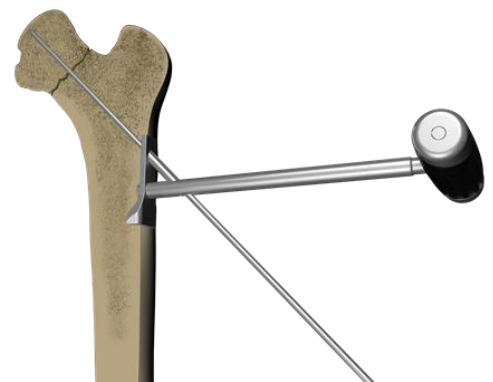



The self-centring Gannet Aiming Device is positioned firmly on the lateral cortex. The anteversion plane is chosen as assessed during the fracture reduction imaging.

The Guide Pin is inserted using an electric drill under image intensification. The Guide Pin should be positioned in the centre of the femoral head in the antero-posterior and axial view; if not, the Guide Pin must be re-inserted.

After the Guide Pin has been positioned in the centre of the femoral head, it is advanced until the tip is located at the planned depth in the femoral head: 5 mm subchondral.

NOTE: As the insertion of the Gannet Blade will not produce any rotational torque it is not necessary to introduce an extra 'anti-rotational' Guide Pin.



Imaging

Confirm by means of the appropriate imaging technique (e.g. fluoroscopy) the correct position and/or direction of the instrument or implant. This is important for correct and safe application of the instrument or implant and prevent harm to patient and/or user.

4. Length determination

The reaming depth, as well as the length of the Gannet Blade, is determined by placing the Gannet Measuring Gauge over the protruding part of the Guide Pin all the way down to the lateral cortex.

The measured size is the actual length of the Gannet Blade.

If the measured size is in between two implant sizes, always choose the longer Gannet Blade length.

After determining the implant size, it is advised to advance the Guide Pin further into the subchondral bone of the femoral head, into the first cortex of the acetabulum.

This is to prevent dislodgment of the Guide Pin during the later drilling procedure. Furthermore, this is also to prevent tilting of the femoral head during the introduction of the Gannet Blade into the femoral head.



Size selection

The Gannet is available in a wide variety of sizes to ensure appropriate sizing of the implanted components. Correct size selection is critical to the surgical outcome. An under- or oversized implant can lead to premature failure of the cage.

5. Drilling

The cannulated Gannet Stepped Drill is set to the measured depth. The Stepped Drill is inserted over the Guide Pin, then the femoral neck and head are pre-drilled to the desired depth until the conical end-stop just touches the lateral cortex of the femur. The conical end-stop will prevent from drilling too deep.

It is strongly advised that at least the last part of the drilling is performed under image intensification. Remove the drill. The Guide Pin is left in place in order to insert the Gannet Blade and Plate.

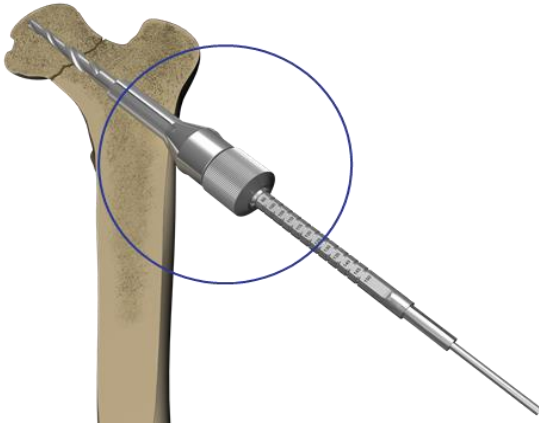

Imaging

Confirm by means of the appropriate imaging technique (e.g. fluoroscopy) the correct position and/or direction of the instrument or implant. This is important for correct and safe application of the instrument or implant and prevent harm to patient and/or user.



Powered instruments

The use of an powered instrument for drilling or driving a bone screw in position can damage the anatomical structures or damage the implant or instruments.



6. Gannet Blade and Plate assembly

Based on the length determined the correct sized Gannet Blade is chosen. Place the selected Gannet Blade in the Support position of the Gannet Instrument Tray. Place the Plate over the shaft of the Gannet Blade.

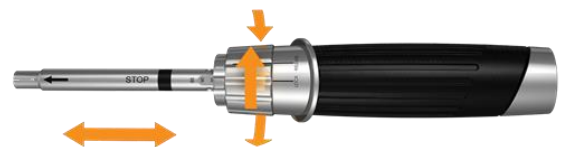

7. Setting the Gannet Introducer

Adjust the Gannet Introducer to the selected Gannet Blade length: Rotate the Locking Ring of the Gannet Introducer and slide the shaft out to the desired length. Return the Locking Ring into its locking position.

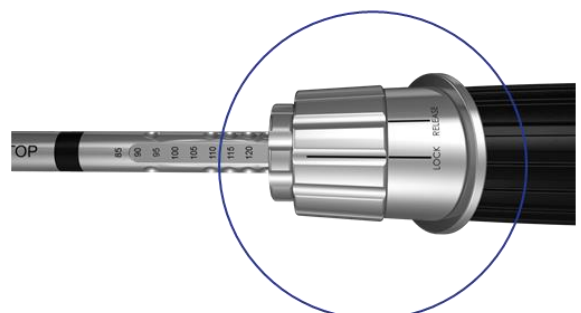

8. Gannet Introducer and Blade and Plate assembly

Position the Gannet Introducer onto the selected Gannet Blade in the Support. Align the arrow on the shaft of the Gannet Introducer with the line marking on the Gannet Blade. Place the Gannet Central Rod through the handle of the Gannet Introducer into the Gannet Implant. Screw the locking rod into the Gannet Blade by turning it clockwise.

Please, do not over tighten!

The assembled Gannet Blade and Plate should now be locked on the Gannet Introducer.



Single activation only

The wings of the Gannet Blade are single use and should not be activated prior to implantation!

9. Gannet Blade and Plate one-step insertion

Place the Gannet Introducer and the mounted Gannet Blade and Plate over the Guide Pin. Insert the Gannet Blade and Plate in the pre-drilled lateral cortex by gently tapping with a hammer, The Plate should be positioned parallel to the axis of the femur.

Insert the Gannet Blade and Plate until the Plate is seated along the lateral cortex.

Release the handle of the Gannet Introducer and slide it fully forward. Gently tap the Gannet Blade into position until the Gannet Introducer reaches the stop. The last part of the insertion is performed under image intensification.

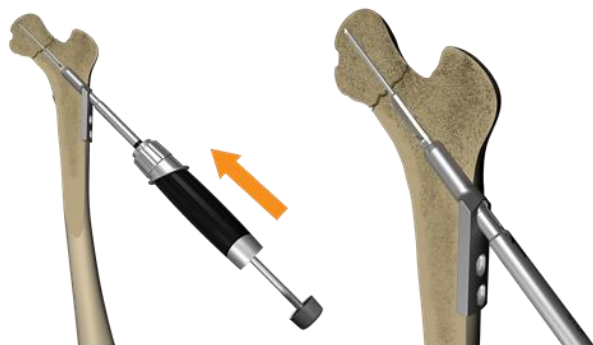
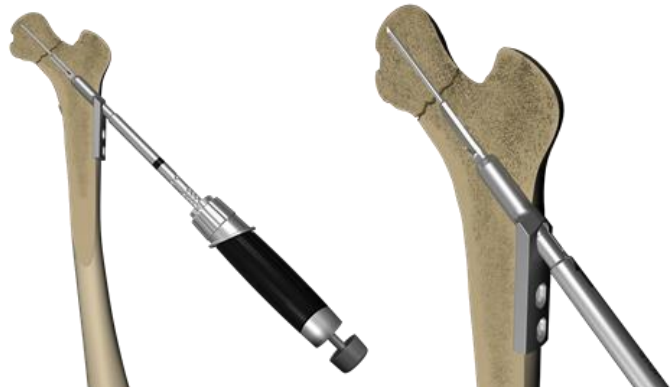

Now the Gannet Blade should be inserted 5 mm subchondral. Remove the Gannet Introducer by turning the central rod counter clockwise. Remove the Guide Pin.



Imaging

Confirm by means of the appropriate imaging technique (e.g. fluoroscopy) the correct position and/or direction of the instrument or implant. This is important for correct and safe application of the instrument or implant and prevent harm to patient and/or user.

10. Plate impaction

If the Plate does not fully abut the femur, the Gannet Impactor should be used. Place the black plastic tip of the Gannet Impactor in the upper cortical screw hole of the Plate and use a hammer to tap the Plate towards the femur.

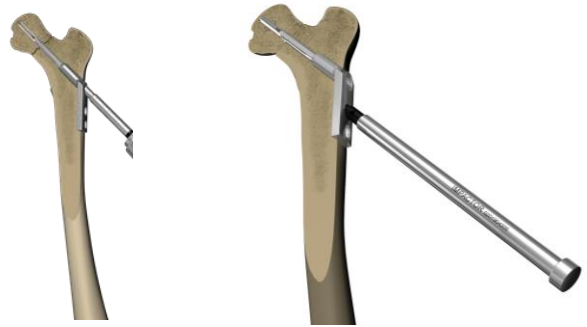

11. Plate fixation

The Plate is fixed to the femur by using two Gannet Self-Tapping Cortical Screws.

Pre-drill bicortical by means of the 3.2 mm cortical Drill and Drill Guide.

Use the Depth Gauge to determine the correct length of the Gannet Self-Tapping Cortical Screws.

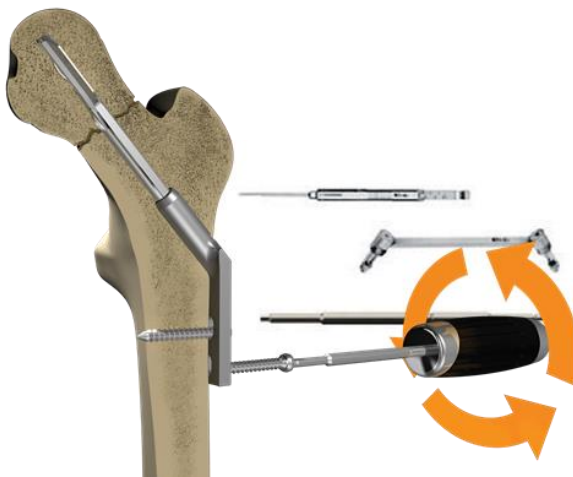

As an alternative to using the Gannet Screw and Anchor Driver, the Screw Driver Insert 3.5 mm may be used in combination with an electric drill to place the Gannet Self-Tapping Cortical Screws.



Powered instruments

The use of a powered instrument for drilling or driving a bone screw in position can damage the anatomical structures or damage the implant or instruments.

12. Gannet Impaction Anchor deployment

Insert the Gannet Screw and Anchor Driver in the setscrew of the Gannet Implant shaft. Deploy the Impaction Anchors by turning the internal setscrew clockwise for about 7 full turns until the end stop is reached.

Make sure the Impaction Anchors are fully deployed with an antero-posterior view using image intensification.



Single activation only

The wings of the Gannet Blade are single use and should not be activated prior to implantation!

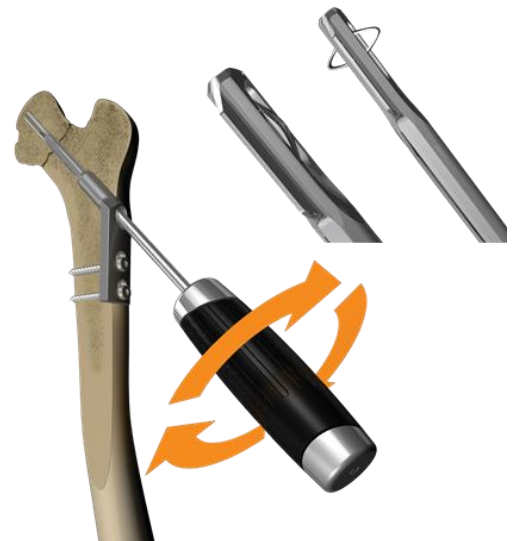

Powered instruments

The use of a powered instrument for drilling or driving a bone screw in position can damage the anatomical structures or damage the implant or instruments.



Imaging

Confirm by means of the appropriate imaging technique (e.g. fluoroscopy) the correct position and/or direction of the instrument or implant. This is important for correct and safe application of the instrument or implant and prevent harm to patient and/or user.

13. Final check and wound closure

Ensure the central positioning of the Gannet Blade by antero-posterior and axial view.
Store the representative X-ray views.

Close the fascia lata, subcutaneous fascia and skin.
Leave a drain if necessary.

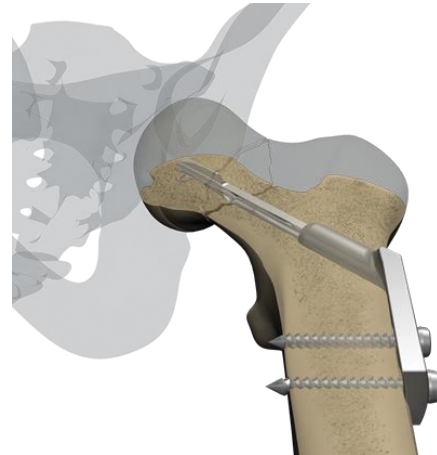

Gannet Implant removal

Procedure overview

1. Approach - Make a ± 8 cm lateral skin incision.
2. Retract the two Impaction Anchors using the Gannet Screw and Anchor Driver.
3. Remove the two Gannet Self-Tapping Cortical Screws using the Gannet Screw and Anchor Driver.
4. Extract the Gannet Blade together with the mounted Plate by means of the Extractor mounted on the Blade.
5. Close the wound in three layers.

1. Approach

A lateral skin incision of ± 8 cm is made downwards from the lower end of the greater trochanter. The subcutis and the fascia lata are split in line with the skin incision. The vastus lateralis muscle is split longitudinally at its posterior border, and reflected upwards. Remove the tissue from the end of the Plate.

2. Retraction of Impaction Anchors



Using the Gannet Screw and Anchor Driver retract the Impaction Anchors. Retraction may be checked by image intensifier to ensure that the Impaction Anchors are fully retracted.

3. Removal of Gannet Self-Tapping Cortical Screws

Remove the Gannet Self-Tapping Cortical Screws with the Gannet Screw and Anchor Driver. Free the Plate from overgrowing tissue/bone.

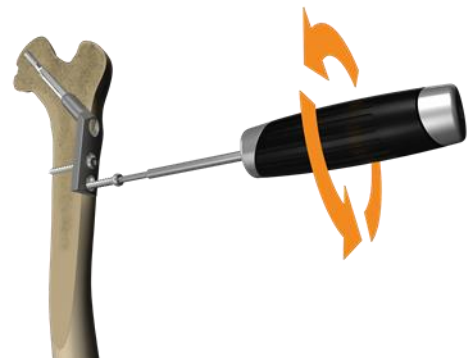

4. Extraction of Gannet Blade and plate

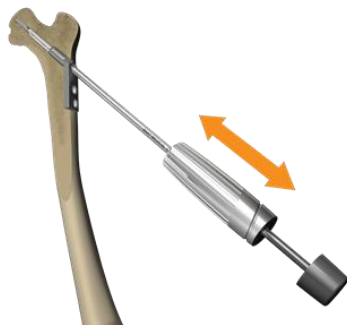

Place the Gannet Extractor on the Gannet Blade, facilitated by the Guide Tip of the Gannet Extractor. Screw the Gannet Extractor onto the Gannet Blade by turning it clockwise. Please, do not over tighten!

Remove the Gannet Blade and mounted Plate by using the sliding handle of the Gannet Extractor to tap the Gannet Implant out of the femoral neck.

5. Final check and wound closure

Wound closure in three layers.

References

- W.H. Roerdink, A.M.M. Aalsma, G. Nijenbanning, A.D.P. van Walsum
The Dynamic Locking Blade Plate, a new implant for intracapsular hip fractures: Biomechanical comparison with the sliding hip screw and Twin Hook
Injury, Int. J. Care Injured 40 (2009) 283-287
- W.H. Roerdink, A.M.M. Aalsma, G. Nijenbanning, A.D.P. van Walsum
Initial promising results of the dynamic locking blade plate, a new implant for the fixation of intracapsular hip fractures: results of a pilot study
Arch Orthop Trauma Surg published online 21 October 2010
- W.H. Roerdink
The Dynamic Locking Blade Plate; innovation in the treatment of femoral neck fractures
Thesis, University of Utrecht 17-05-2011
ISBN: 978-94-6108-152-0
- A. D. P. van Walsum · J. Vroemen · H. M. J. Janzing · T. Winkelhorst · J. Kalsbeek · W. H. Roerdink
Low failure rate by means of DLBP fixation of undisplaced femoral neck fractures
European Journal for Orthopaedics and Trauma, April 2016
- J. H. Kalsbeek, A. D. P. van Walsum, J. Vroemen, H. M. J. Janzing, T. Winkelhorst, B. P. Bertelink, W. H. Roerdink.
Displaced femoral neck fractures in patients 60 years of age or younger; results of internal fixation with the Dynamic Locking Blade Plate
The Bone and Joint Journal, april 2018

Ordering Information

Gannet Implants and Gannet Instruments can be ordered via your Gannet distributor. Please refer to the Ordering Catalogue below.

Catalogue

Gannet Blade

<i>Part number</i>	<i>Description</i>
2019.GA.085S	GANNET Blade 85mm
2019.GA.090S	GANNET Blade 90mm
2019.GA.095S	GANNET Blade 95mm
2019.GA.100S	GANNET Blade 100mm
2019.GA.105S	GANNET Blade 105mm
2019.GA.110S	GANNET Blade 110mm
2019.GA.115S	GANNET Blade 115mm
2019.GA.120S	GANNET Blade 120mm



Plate

<i>Part number</i>	<i>Description</i>
2019.GP.135S	GANNET 135° 2-hole Plate
2019.TP.135S	GANNET 135° 3-hole Plate













Gannet Self-Tapping Cortical Screws

<i>Part number</i>	<i>Description</i>
2019.SC.034S	GANNET Self-Tapping Cortical Screw 4.5x34mm
2019.SC.036S	GANNET Self-Tapping Cortical Screw 4.5x36mm
2019.SC.038S	GANNET Self-Tapping Cortical Screw 4.5x38mm
2019.SC.040S	GANNET Self-Tapping Cortical Screw 4.5x40mm
2019.SC.042S	GANNET Self-Tapping Cortical Screw 4.5x42mm
2019.SC.044S	GANNET Self-Tapping Cortical Screw 4.5x44mm
2019.SC.046S	GANNET Self-Tapping Cortical Screw 4.5x46mm
2019.SC.048S	GANNET Self-Tapping Cortical Screw 4.5x48mm



Gannet Instruments

<i>Part number</i>	<i>Description</i>	
2019.GI.INT	GANNET Introducer	
2019.GI.SAD	GANNET Screw and Anchor Driver	
2019.GI.EXT	GANNET Extractor	
2019.GI.AID	GANNET Aiming Device	
2019.GI.SDR	GANNET Stepped Drill	
2019.GI.MEG	GANNET Measuring Gauge	
2019.GI.GPI	GANNET Guide Pin (Ø3x310mm)	
2019.GI.DRI	GANNET Drill, 3.2mm	
2019.GI.DEG	GANNET Depth Gauge	
2019.GI.DRG	GANNET Drill Guide (Drill, 3.2mm)	
2019.GI.SDI	GANNET Screw Driver Insert 3.5mm	
2019.GI.IMC	GANNET Impactor	
2019.GI.IMT	GANNET Impactor Tip	
2019.GI.TRY	GANNET Tray	