

SHARX[®] PLIF, oblique TLIF

INSTRUMENTATION GUIDE

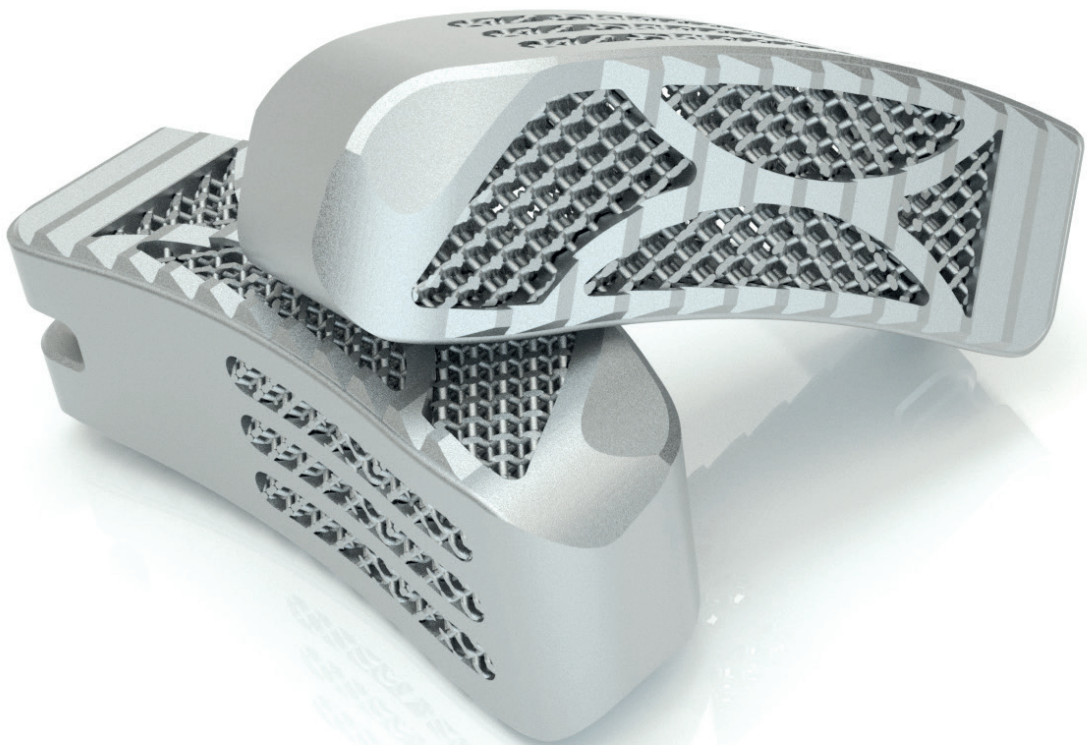

TABLE OF CONTENTS

Intended use	3
Indications	3
Contraindications	3
Warnings	4
Sharx – Instrumentation	5
PRODUCT INFORMATION	11
Sharx Implants	PI 02
Sharx Trial Implants	PI 04
Sharx Instruments	PI 05
General Instruments	PI 05
Sharx Alphabetical Index	PI 06

Intended use

The sharx cages are single use interbody fusion cages and have been developed for single or multi-level lumbar and/or lumbosacral interbody fusion. The implant is intended for insertion between two adjacent vertebrae. In combination with autograft or allograft, (excluding therapeutic biologic: e.g., bone morphogenic protein), a posterior rod and screw system and, if applicable an anterior plate, the cages restore intervertebral height of the spinal segment and facilitate osteosynthesis. The devices are used in a standard operating room environment by trained orthopaedic and neurosurgeons.

See also the WARNINGS in this instrumentation guide.

Indications

The sharx cage is intended for the treatment of chronic low back and leg pain due to degenerative changes in the lumbar spine:

- Degenerative Disc Disease (DDD) with a specific discogenic pain pattern
- Spondylolisthesis (up to grade 1)
- Instability of the anterior column in association with posterior pathology

Contraindications

Do not use the sharx cage in cases of:

- Reduced bone quality (e.g. osteoporosis or bone decalcification)
- Fractures
- Tumors
- Active infection
- Local inflammation
- Primary spinal deformities
- Allergy to titanium or its alloys

MR SAFETY A patient with this implant/device can be scanned safely immediately after placement under the following conditions:

- Static magnetic field of 3-Tesla or less
- Maximum spatial gradient magnetic field of 720-Gauss/cm (a higher value for the spatial gradient magnetic field may apply if properly calculated).
- Maximum MR system reported whole-body-averaged specific absorption rate (SAR) of 2-W/kg for 15 minutes of scanning (per pulse sequence).

In all cases, the Health Care Professional is responsible for MR Conditions, MR Imaging quality and patient safety. Any safety issues or major image artefacts should be reported.



MRI-Related Heating

In non-clinical testing, comparable devices produced a temperature rise of less than or equal to 6.0 degrees C using an MR system reported, whole body averaged specific absorption rate (SAR) of 2-W/kg for 15-minutes (per pulse sequence) of scanning in a 3-Tesla MR system.

Artifact

MR image quality may be compromised if the area of interest is in the exact same area or relatively close to the position of the implant/device. In some cases, the artifact size relative to the size of the implant or device may be indicated.

Attention: Contact the manufacturer of this implant/device for further information, as needed.

Warnings

Potential risks identified with the use of this system include:

- Cardio/vascular complications (blood loss, disturbed blood supply, vessel injury, hematoma)
- Neurologic complications (dural tear, neurologic impairment/deficits, CSF leakage)
- Pulmonary complications
- Urologic complications
- Infection and wound healing problems
- Non-union / delayed fusion / pseudoarthrosis
- Implant failure (breakage)
- Implant migration
- Implant malpositioning
- Implant subsidence
- Postoperative pain
- Intolerance to the material / allergic reaction to cage material
- Osteolysis
- Altered biomechanics resulting in pain / adjacent segment degeneration
- Complications related to additional instrumentation (e.g. screw breakage, screw malpositioning)

SHARX[®] INSTRUMENTATION

Pre-surgical planning

Perform appropriate patient selection and inform patient of limitations and potential adverse effects of the surgery. Patients must be skeletally mature and have had at least six months of non-operative treatment. Ensure implants and the designated instrument set are available and ready for use (see Instructions for Use for cleaning and sterilization instructions of the instruments).



PATIENT SELECTION Appropriate patient selection is critical to the surgical outcome. Only patients who satisfy the indications AND who do not have any of the contraindications should be considered for interbody fusion surgery using the sharx cage to avoid adversely affecting device performance or surgical outcome.



INSTRUMENTS Only use instruments and accessories listed in the surgical technique to avoid adversely affecting device performance or surgical outcome. The surgical team must verify that the instruments are in good condition and in operating order prior to use during surgery.



PATIENT EDUCATION Preoperative instructions to the patient are essential. The patient should be made aware of the limitations and potential adverse effects of the surgery. The patient should be instructed to limit the postoperative activity as this will reduce the risk of bending, breaking and/or loosening the implants. The patient must be made aware that implant components may bend, break and/or loosen, even though restrictions in activity are followed.



END USERS The surgeon should strictly follow the recommendations in the surgical technique and all staff involved should be familiar with the surgical procedures associated with the lumbar interbody fusion technique to avoid adversely affecting device performance or surgical outcome.

Surgical steps

PREPARATION AND APPROACH

The patient is positioned in prone position on the OR table. Make sure to allow for X-ray examinations by C-arm (AP and Lateral).

Confirm the affected level(s) using imaging techniques.

Create access to the intradiscal space via standard posterior or transforaminal approach. (Partially) remove the lamina, facet joints and/or spinous process as needed.

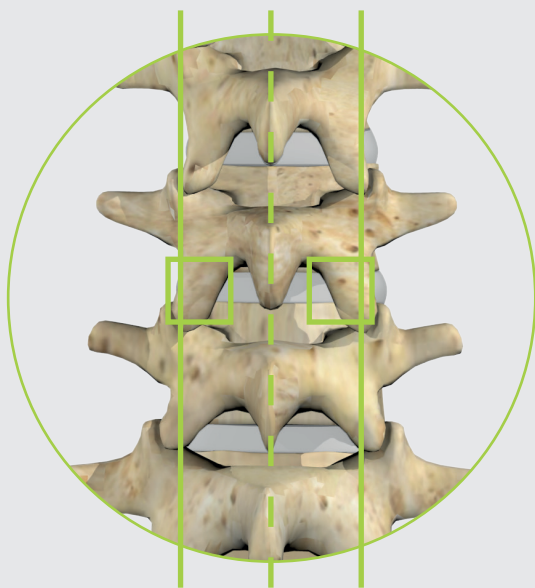

PLIF

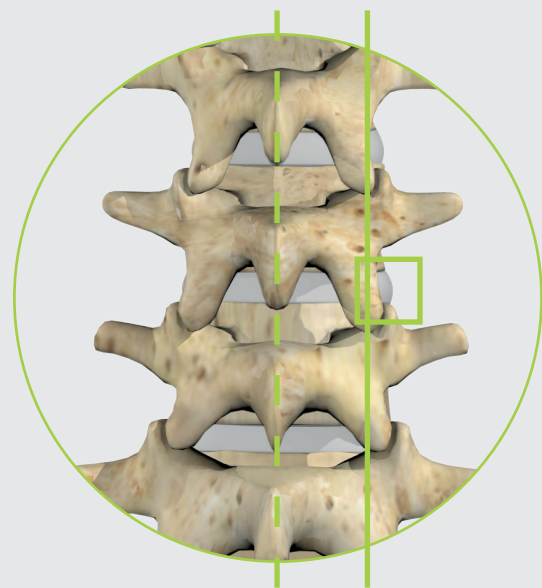

Oblique TLIF

Surgical steps

DISCECTOMY AND ENDPLATE PREPARATION

Perform discectomy with standard instruments (rongeurs, forceps). Expose the bony endplates.

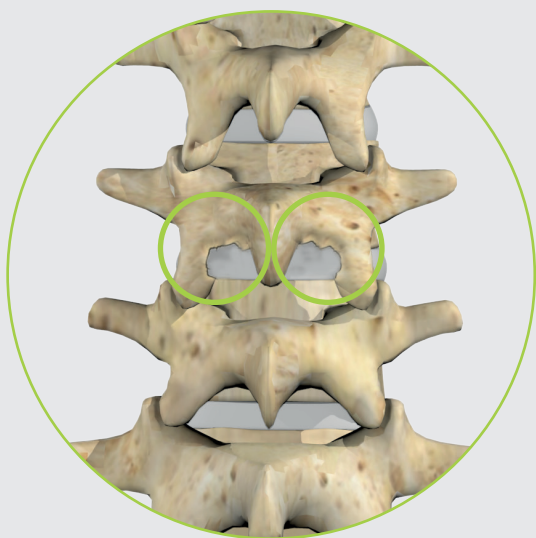

PLIF

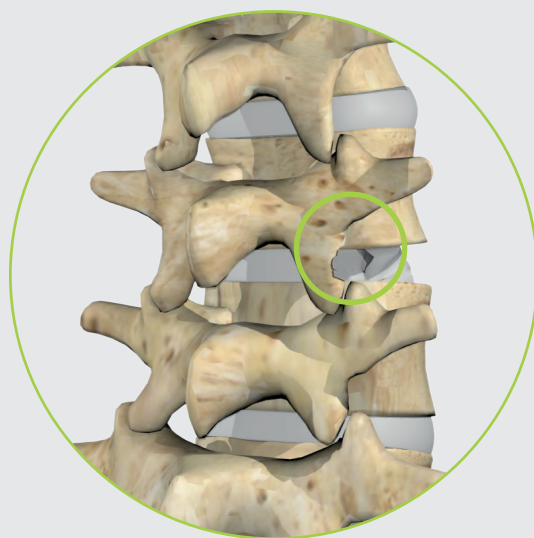

Oblique TLIF



ENDPLATE PREPARATION Appropriate removal of the cartilaginous layers of the endplates is important for the vascularization of the bone graft. However, make sure to clean the endplates carefully and maintain the integrity of the underlying bony endplate, as damage of the endplate can lead to implant subsidence.



DISTRACTION Adequate distraction is one of the preconditions for the primary stability of the implant; however, it is critical to ensure that the segment is not over distracted to avoid damage of ligaments and/or endplates.

Trial insertion and determination of cage size

Insert the Trial sizer with gentle taps on the back of the handle until it is fully seated in the intervertebral space. Start with a small size and repeat using the next larger size, sequentially until the Trial sizer fits tightly in the disc space, the lordotic curve is reached and the nerve roots are adequately released. Check the secure fit and final position of the trial with fluoroscopy. Remove the Trial after cage size determination.



SIZE SELECTION The sharx cages are available in a wide variety of sizes to ensure appropriate sizing of the implanted components. Correct size selection is critical to the surgical outcome. An under- or oversized implant can lead to premature failure of the cage.

Implant insertion

Use standard aseptic practice to open the sterile packaging of the implant size that was determined with the Trial.

Attach the implant to the inserter. Align the front of the implant with the tip of the inserter and make sure the tip slides into the openings of the implant interface. Rotate the knob at the back clockwise until the implant is securely seated in the tip of the inserter.

Bone graft and/or bone graft substitute might be added into the opening of the cage. Add this after attachment of the inserter, to avoid bone graft build up in the implant-inserter interface hindering a proper implant-inserter attachment.

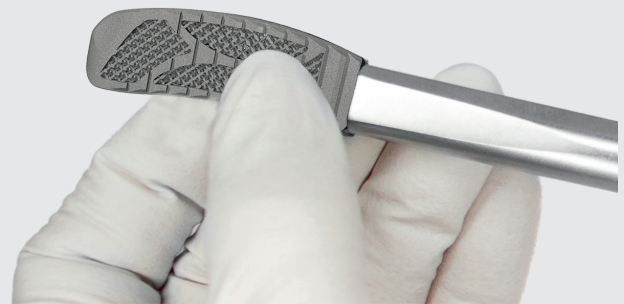
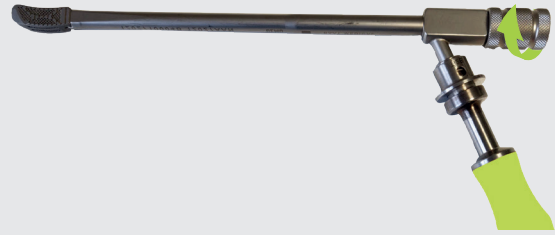

USE-BY DATE AND STERILITY Before using the sharx cage check the use-by date (YYYY/MM/DD). Do not use the implant after the use-by date, this can lead to infection.



IMPLANT HANDLING The cages should be handled appropriately to protect them from unintentional damage. Avoid scratching or damaging the cage at any time (specifically during attachment of the implant to the inserter and implant placement), as this may lead to premature failure of the cage. Do not use damaged implants.



PACKAGING INTEGRITY Before use of the sharx cage check if the secondary packaging, labelling and sterile primary packaging are intact. The sterile packaging should be free of cracks, holes, tears and any other damage. Use of an Implant from a damaged packaging can lead to an untraceable product or infection.

Implant insertion

Insert the implant with gentle taps on the back of the inserter until the implant is in the intervertebral space. Position the implant in the PLIF position or the oblique TLIF position.

Check the secure fit and final position of the implant with fluoroscopy. If the implant position is adequate, remove the inserter by rotating the inserter knob counter clockwise.

Depending on surgical preference, the disc space can be filled prior to and after cage implantation with remaining bone graft and /or bone graft substitute.

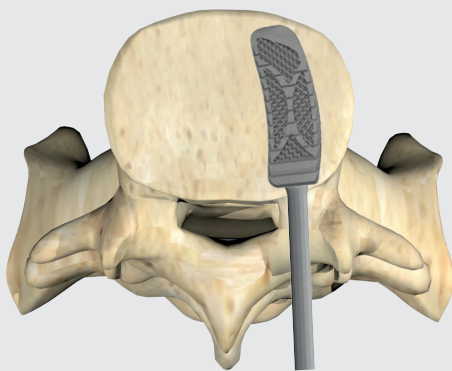

PLIF

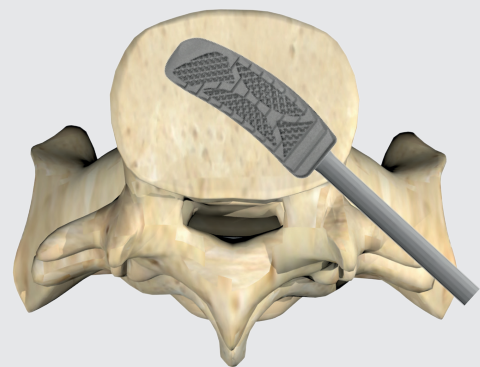

Oblique TLIF

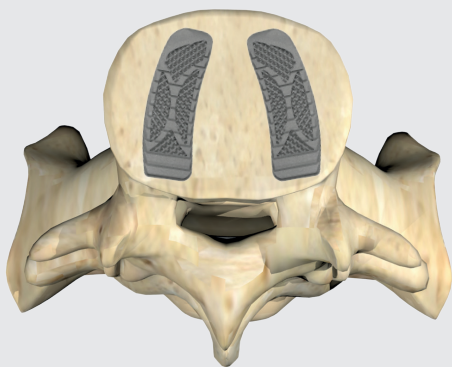

PLIF

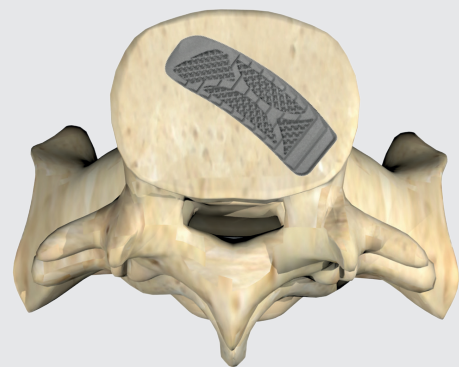

Oblique TLIF



IMPLANT PLACEMENT The sharx cage has teeth to maximize primary stability, however make sure the soft tissues are adequately retracted when inserting the implant to avoid damage from contact with the cage (in particular the rough cranial and caudal surfaces). Adequate implant positioning is critical; an improperly placed implant can adversely affect device performance or surgical outcome.

Implant removal; Postoperative; Disposal

Implant removal

The sharx cage is intended for permanent implantation and is not intended to be removed in case of a good outcome. However, adverse events might warrant removal of the implant.

Dissect the bone, attach the inserter to the implant and remove the implant.

Postoperative

The patient should be instructed to limit the postoperative activity as this will reduce the risk of bent, broken and/or loose implant components.

Postoperative evaluation of the fusion and the implant status are mandatory.

Disposal

The disposal of this medical product requires no special measures. Be sure to observe all national/local regulations and guidelines when disposing of the packaging material and potentially infectious items.



PERMANENT IMPLANTATION The device is intended for permanent implantation and shall not be removed in case of good outcome. Removal of a stable implant can lead to loss of stability and damage to the surrounding tissue.



SINGLE USE ONLY The sharx cages are provided as single use implants only, and are not to be reused, resterilized or reimplanted in any situation as this might adversely affect device performance and/or increase risk of infection.

SHARX[®] PLIF, oblique TLIF PRODUCT INFORMATION

Sharx Implants by article number	PI 02
Sharx Trial Implants by article number	PI 03
Sharx Instruments by article number	PI 04
General Instruments by article number	PI 04
Sharx Alphabetical Index	PI 05

Sharx® Implants

Article number explanation for the cage, as an example

Sharx Cage, 28 x 10, 12° lordosis

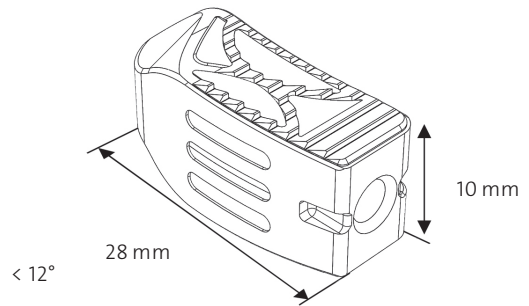
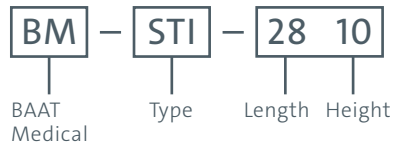

System:
Sharx

Implant type:
PLIF, oblique TLIF

Typing:
25 mm

Material:
Ti6Al4VELI

Article number	Description	Illustration
BM-STI2506	sharx 25 x 6 x 0 deg	
BM-STI2508	sharx 25 x 8 x 0 deg	
BM-STI2510	sharx 25 x 10 x 0 deg	
BM-STI2512	sharx 25 x 12 x 0 deg	
BM-STI2514	sharx 25 x 14 x 0 deg	

System:
Sharx

Implant type:
PLIF, oblique TLIF

Typing:
28 mm

Material:
Ti6Al4VELI

Article number	Description	Illustration
BM-STI2806	sharx 28 x 6 x 2 deg	
BM-STI2808	sharx 28 x 8 x 12 deg	
BM-STI2810	sharx 28 x 10 x 12 deg	
BM-STI2812	sharx 28 x 12 x 12 deg	
BM-STI2814	sharx 28 x 14 x 12 deg	

Sharx® Implants

Article number	Description	Illustration
BM-STI3206	sharx 32 x 6 x 2 deg	
BM-STI3208	sharx 32 x 8 x 12 deg	
BM-STI3210	sharx 32 x 10 x 12 deg	
BM-STI3212	sharx 32 x 12 x 12 deg	
BM-STI3214	sharx 32 x 14 x 12 deg	

System:
Sharx

Implant type:
PLIF, oblique TLIF

Typing:
32 mm

Material:
Ti6Al4VELI

Sharx® Trial Implants

Article number	Description	Illustration
BM-1202710306	sharx Trial sizer 6 mm	
BM-1202710308	sharx Trial sizer 8 mm	
BM-1202710310	sharx Trial sizer 10 mm	
BM-1202710312	sharx Trial sizer 12 mm	
BM-1202710314	sharx Trial sizer 14 mm	









System:
Sharx

Instrument type:
Trial sizer

Typing:
6-14 mm

Material:
Stainless steel (17-4PH)

Sharx® Instruments

Article number	Description	Illustration
BM-1202710004A	Implant Holder Pin	
BM-1202710004B	Implant Holder Tube	
BM-1202710130	Sizer 28/32	
BM-1202710406	Paddle Shaver 6 mm	
BM-1202710408	Paddle Shaver 8 mm	
BM-1202710410	Paddle Shaver 10 mm	
BM-1202710412	Paddle Shaver 12 mm	
BM-1202710414	Paddle Shaver 14 mm	
BM-EHM	Extraction Hammer	
BM-SQH	Handle, straight, 1/4 inch connection on both sides	

General Instruments

Article number	Description	Illustration
GI-3101	T-Handle	

Sharx® Alphabetical Index

A-Z	Description	Article number
E	Extraction Hammer	BM-EHM
H	Handle, straight, 1/4 inch connection on both sides	BM-SQH
I	Implant Holder Pin	BM-1202710004A
	Implant Holder Tube	BM-1202710004B
P	Paddle Shaver 6 mm	BM-1202710406
	Paddle Shaver 8 mm	BM-1202710408
	Paddle Shaver 10 mm	BM-1202710410
	Paddle Shaver 12 mm	BM-1202710412
	Paddle Shaver 14 mm	BM-1202710414
S	sharx Trial sizer 6 mm	BM-1202710306
	sharx Trial sizer 8 mm	BM-1202710308
	sharx Trial sizer 10 mm	BM-1202710310
	sharx Trial sizer 12 mm	BM-1202710312
	sharx Trial sizer 14 mm	BM-1202710314
	Sizer 28/32	BM-1202710130
T	T-Handle	GI-3101

Notes

A series of horizontal dotted lines for writing notes.



www.silony-medical.com

 **Silony Medical Europe GmbH**
An der Weide 27-29
28195 Bremen, Germany
Tel +49 421 24 69 56 0
Fax +49 421 24 69 56 55

 **BAAT Medical Products B.V.**
F. Hazemeijerstraat 800
7555 RJ Hengelo, The Netherlands
Tel +31 (0)88 565 66 00

 0344